

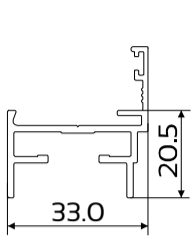

crealco | CASEMENT 34 WINDOW (34mm)

Profiles



DIE No. W33134 Cas34 Frame 34mm Short Leg

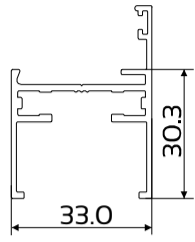

DIE No. W32039 Equal Leg Outer Frame

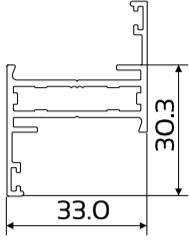

DIE No. W55691 Tubular Sash

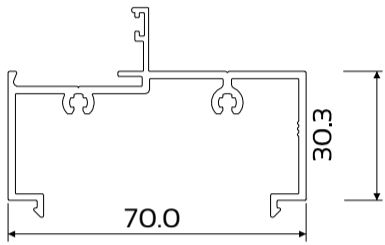

DIE No. W33135 Cas34 Frame 70mm

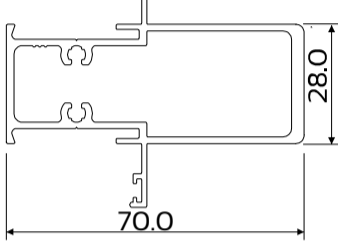

DIE No. W56270 Cas34 70mm Mullion

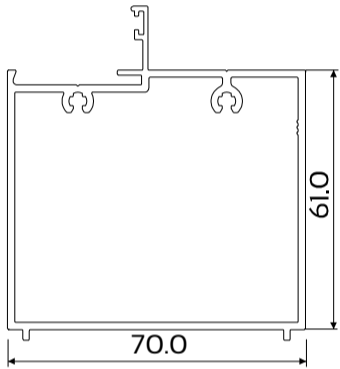

DIE No. W56272 Cas34 Frame 70mm Boxed Sill

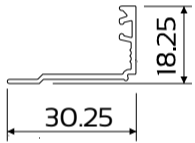

DIE No. W33136 Cas34 Bead Double Glaze

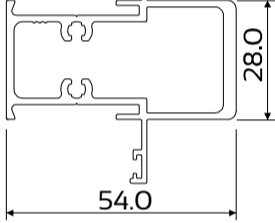

DIE No. W56269 Cas34 54mm Mullion

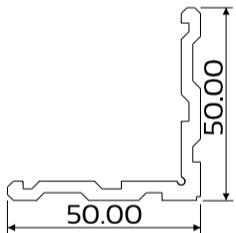

DIE No. CL10241P Cas34 Corner Cleat

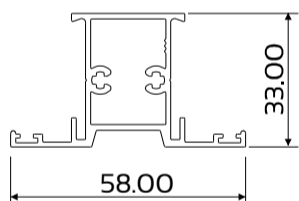

DIE No. W55692 Cas34 Mullion

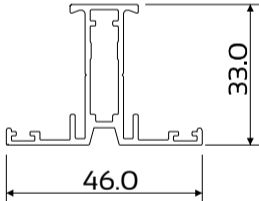

DIE No. W56271 Cas34 Mullion 34mm Cottage Pane

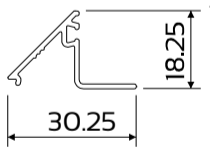

DIE No. W33137 Cas34 Bead Multi 13mm

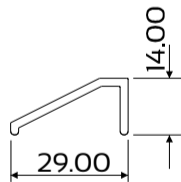

DIE No. W10083 Cas34 Add On Weather Bar

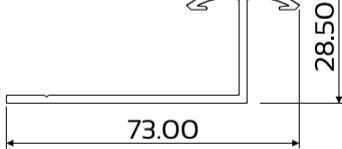

DIE No. W10627 Fixing Lug

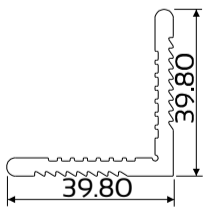

DIE No. W52538 Osborne Multi Corner Cleat

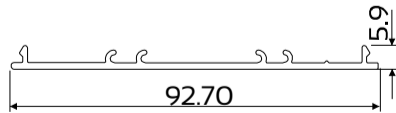

DIE No. W30607 Multi Fixing Lug Alum 15mm

Elevations & Sections

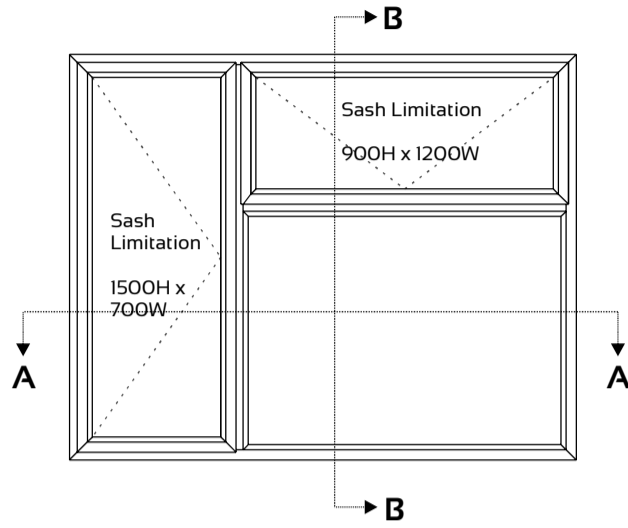

Maximum Sash Sizes (WxH) to suit Friction Stay		
Standard Sash	Top Hung	1200 x 900
	Side Hung	700 x 1500
Double Glazing	Top Hung	1200 x 900
	Side Hung	700 x 700

SECTION B-B Section not to scale

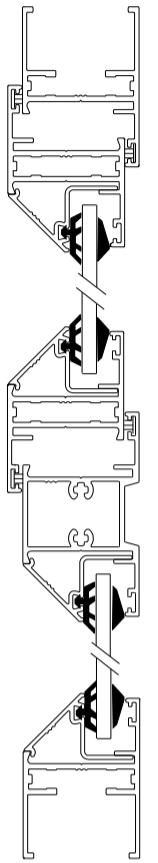

SECTION A-A Section not to scale

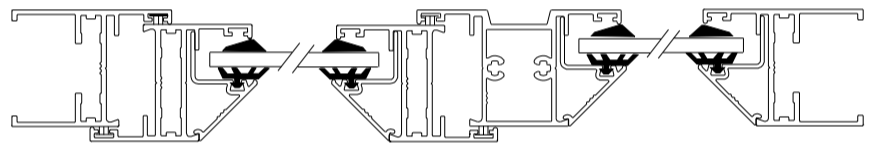

SECTION B-B Section not to scale

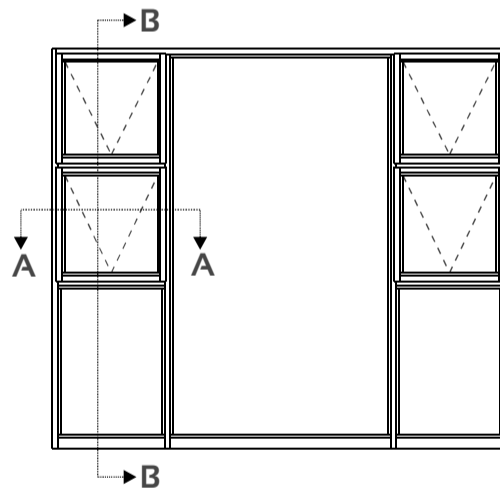

SECTION A-A Section not to scale

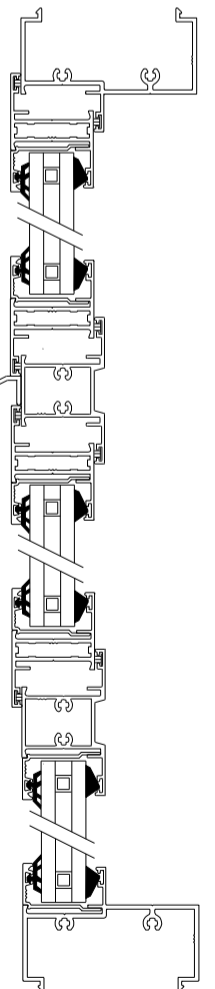
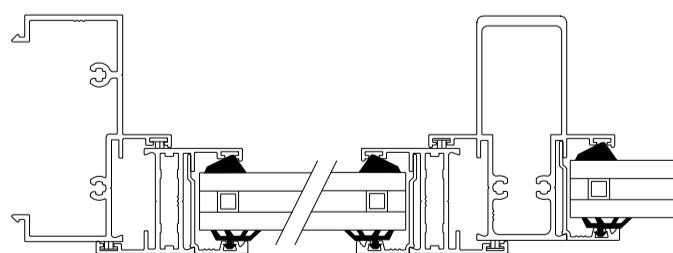

Disclaimer: The right to make alterations is reserved.

Please refer to system manual for additional information

© Copyright 2015, Wispeco (Pty) Ltd.

October 2016

EDENVALE
Shop 13
Meadowdale Value City
Herman Road, Edenvale, Jhb
Postnet Suite 37
Private Bag X10020
Edenvale, 1610
Tel: +27 11 454 0300
Fax: +27 11 454 0475
Theuns du Plessis
theuns@conways.co.za

PRETORIA
Willows Business Park
cnr Bearing Cr & Petrol Str
Watloo, Silverton, Pretoria
Postnet Suite 37
Private Bag X10020
Edenvale, 1610
Tel: +27 12 803 7989
Fax: +27 12 803 7988
Francois Reyneke
francois@conways.co.za

DURBAN
20 Ebonyfield Avenue
Springfield Park
Durban
PO Box 74460
Rochdale Park
4034
Tel: +27 31 579 8300
Fax: +27 31 579 8301
Steffanie Schuster
steffanie@conways.co.za

CAPE TOWN
24 Montague Drive
Montague Gardens
Cape Town
PO Box 36603
Chempet
7442
Tel: +27 21 528 1100
Fax: +27 21 528 1101
Vivian Theys
vivian@conways.co.za

PORT ELIZABETH
5 Herbert Street
Korsten
Port Elizabeth
PO Box 14255
Sidwell
6000
Tel: +27 41 404 1900
Fax: +27 41 453 0669
Vivienne Wilken
vivienne@conways.co.za

LIMPOPO
Unit 4B, Danielle Close
Corporate Park 2
Magna via Polokwane
PO Box 124167
Alrode
1451
Tel: +27 81 756 7550
Fax: +27 15 298 8138
Wade May
wade@conways.co.za

NELSPRUIT
Unit D, 4 Rapid Street
Riverside Industrial Park
Nelspruit
PO Box 2590
White River
1240
Tel: +27 13 752 3199
Fax: +27 13 752 3231
Marius van Vuuren
mariusv@conways.co.za

CONWAYS
Est. 1946
Aluminium Profile Stockists